



# Bodyguard

## Fester Halt.

■ Ideal für das barrierefreie Bad und absoluter Preis-/Leistungssieger. Bodyguard Basic wird aus Edelstahl und verzinktem Stahl gefertigt, der mit abriebfestem Polyester beschichtet ist. Diese spezielle Oberfläche garantiert auch im nassen Zustand festen Halt.

Sicherheit ist oberstes Gebot. Bei fachmännischer Montage weist Bodyguard Basic eine Tragfähigkeit von 150 kg auf. Aufgrund der sehr großen Anzahl an Formen ergeben sich vielfältige Einsatzmöglichkeiten.

Sämtliche Bauteile sind gemäß UNI-CNR 1002185-1011/85 hergestellt und geprüft.



### Mengenrabatt nicht sortenrein

ab 5 Stück	ab 10 Stück	ab 20 Stück
5 %	10 %	15 %

### Sicherheitshalte- und Stützgriffe

Edelstahl/verzinkter Stahl

stoßfest, abriebfest, pulverbeschichtet

chemisch widerstandsfähig, bakterienhemmend

Rosetten Ø 75 mm für verdeckte Verschraubung,  
Profilrohr Ø 32 mm x 1,5 mm







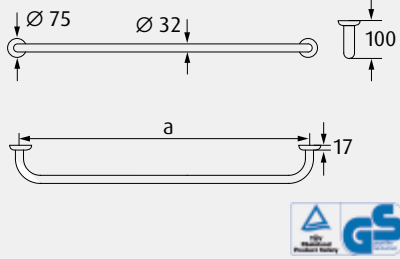

belastbar bis 150 kg

Die Produkte entsprechen den Richtlinien  
EWG 93/42 „Medizinische Einrichtungen“

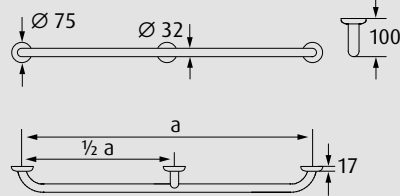

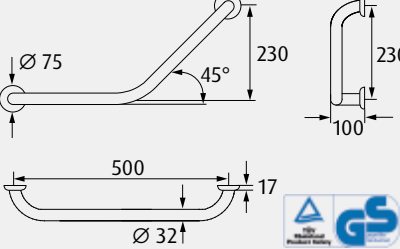

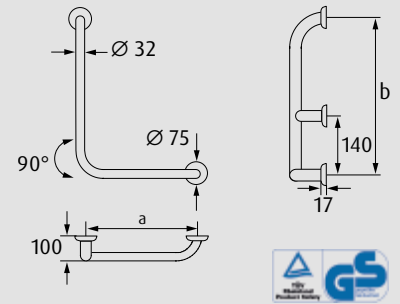

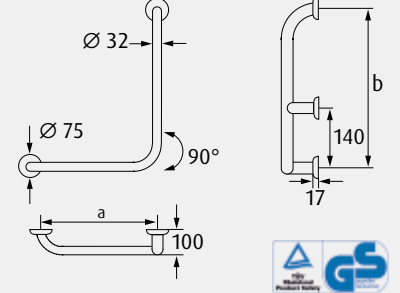
Sondermaß möglich



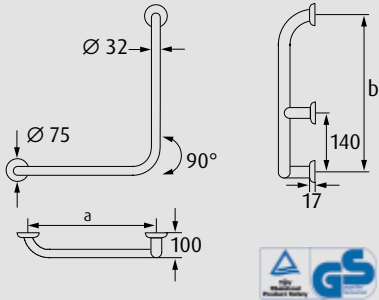

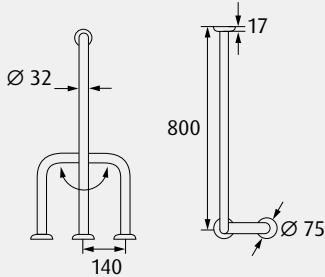

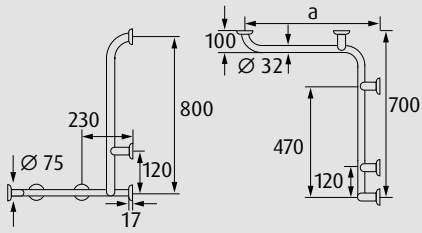

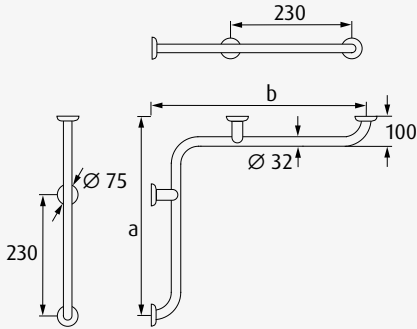
02 RAL 9016

	Skizze	Artikel	Artikel-Nr.
		<b>Griff</b> 300 (a) mm 400 (a) mm 450 (a) mm 500 (a) mm 600 (a) mm 800 (a) mm 900 (a) mm 1100 (a) mm 1200 (a) mm	BBG-300-02 BBG-400-02 BBG-450-02 BBG-500-02 BBG-600-02 BBG-800-02 BBG-900-02 BBG-1100-02 BBG-1200-02
		<b>Griff mit Mittelstütze</b> 1300 (a) mm 1500 (a) mm 2000 (a) mm	BBGM-1300-02 BBGM-1500-02 BBGM-2000-02
		<b>Griff 45°</b> 500 mm	BB-12-02
		<b>Griff 90° links</b> 400 (a) x 700 (b) mm	BB-13-02
		<b>Griff 90° rechts</b> 400 (a) x 700 (b) mm	BB-14-02

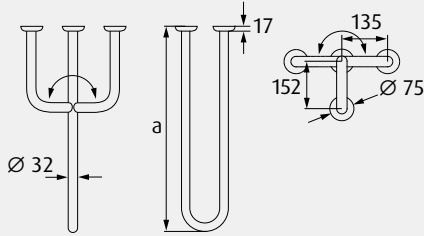

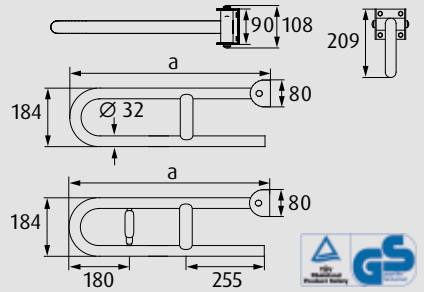

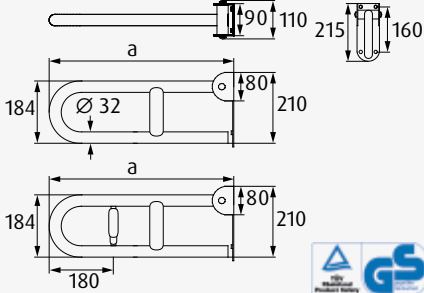
Technische Änderungen vorbehalten.

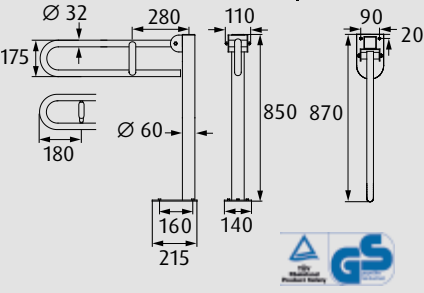
	Skizze	Artikel	Artikel-Nr.
 <p>Abbildung ähnlich.</p>		<b>Griff 90°</b> 500 (a) x 500 (b) mm  B-15-02	BB-15-02
		<b>Wand-/Fußbodenstange mit Universalverstärkung</b> 800 x 800 mm	BB-17-02
		<b>Winkelgriff mit seitlicher Universalvertikalstange</b> 700 (a) x 700 x 800 mm 1200 (a) x 700 x 800 mm	BBW-700-700-800-02 BBW-1200-700-800-02
		<b>Sicherheits-Winkelgriff</b> 700 (a) x 700 (b) mm 1200 (a) x 700 (b) mm 1000 (a) x 1000 (b) mm 1200 (a) x 1200 (b) mm	BBS-700-700-02 BBS-1200-700-02 BBS-1000-1000-02 BBS- 1200-1200-02

Technische Änderungen vorbehalten.

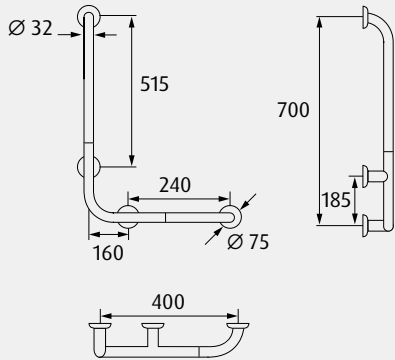
	Skizze	Artikel	Artikel-Nr.
		<b>Haltestange mit Universalverstärkung</b> 600 (a) mm 800 (a) mm	BBH-600-02 BBH-800-02
		<b>Kipp-Haltestange mit vertikaler Arretierung</b> 600 (a) mm 800 (a) mm 800 (a) mm mit Rollenhalter	BBK-600-02 BBK-800-02 BBK-800R-02
Abbildung mit Rollenhalter			
		<b>Kippstange mit langer Fliese und vertikaler Arretierung</b> 600 (a) mm 700 (a) mm 700 (a) mm mit Rollenhalter 800 (a) mm 800 (a) mm mit Rollenhalter	BBF-600-02 BBF-700-02 BBF-700R-02 BBF-800-02 BBF-800R-02
Abbildung ohne Rollenhalter			
		<b>Kippstange an Säule mit vertikaler Arretierung</b> 850 x 870 mm 850 x 870 mm mit Rollenhalter	BBKS-850-870-02 BBKS-850-870R-02
Abbildung ohne Rollenhalter			

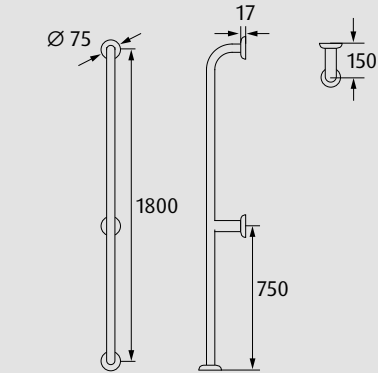
Technische Änderungen vorbehalten.

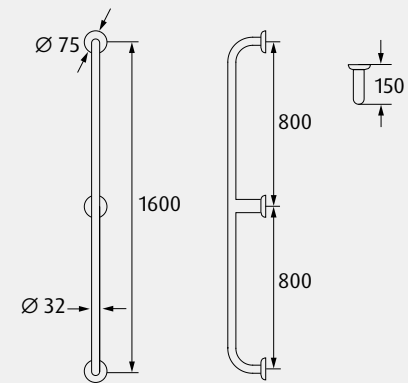
	Skizze	Artikel	Artikel-Nr.
		<b>Griff mit seitlicher Universalvertikalstange</b> 400 x 700 mm	BB-47-02
		<b>Vertikaler Handlauf mit Wand-/Fußbodenbefestigung</b> 1800 mm	BB-49-02
		<b>Vertikaler Handlauf mit Wandbefestigung</b> 1600 mm	BB-50-02

Technische Änderungen vorbehalten.

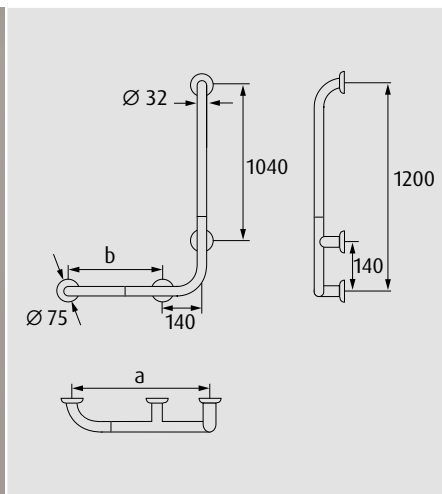
	Skizze	Artikel /mm	Artikel-Nr.
		<p><b>Duschstange mit Griff</b> Duschstange Brausehalter, Handbrause und Brauseschlauch verchromt,</p> <p>400 (a) x 1200 x 260 (b) 600 (a) x 1200 x 460 (b)</p>	<p>BBD-400-1200-02 BBD-600-1200-02</p>

Technische Änderungen vorbehalten.